

# Akali

## 6W Front 4CCT Selectable IP65 Dimmable Recessed Downlight

lediant®

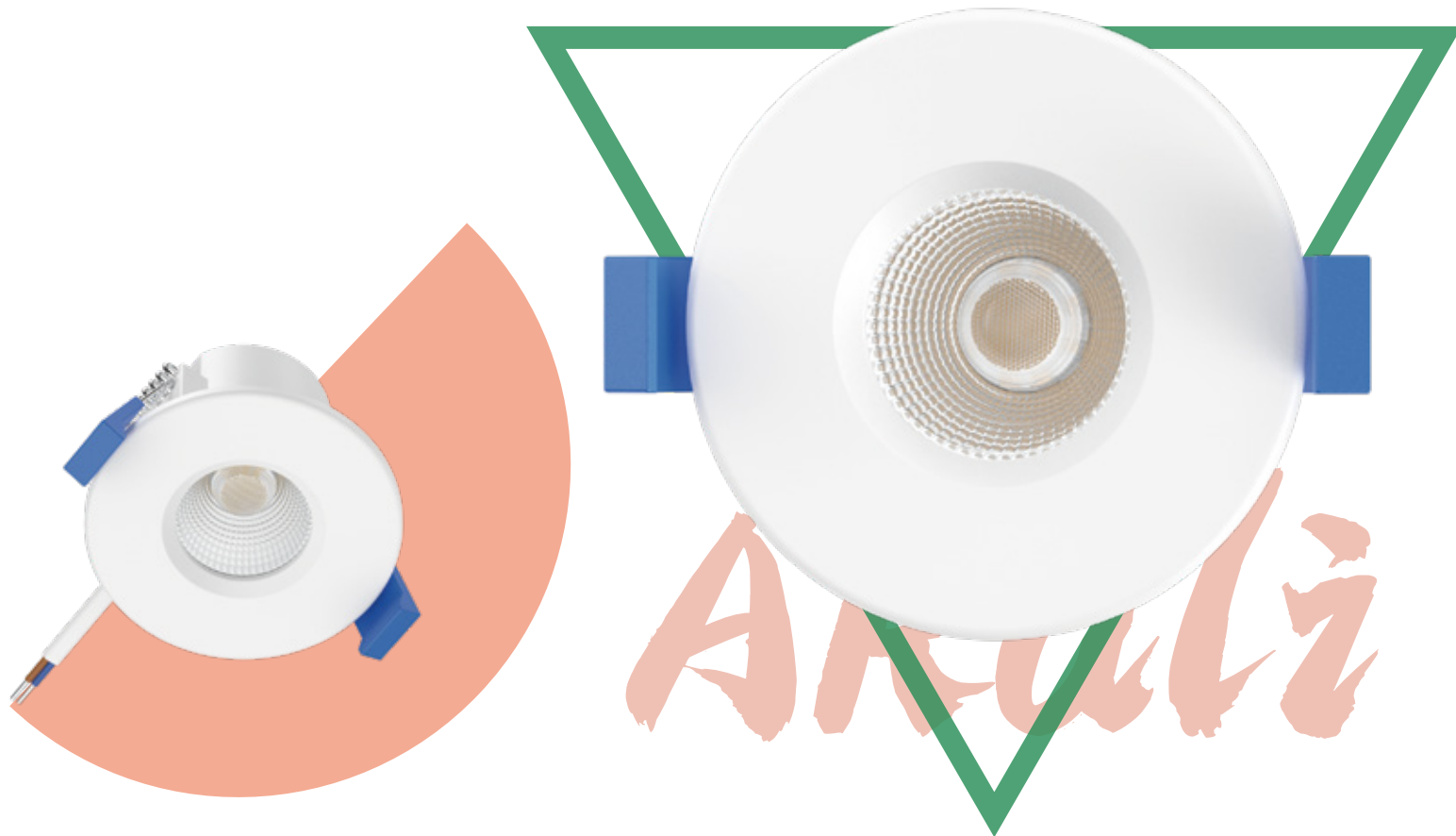

Akali SMD 6w downlight gives around 510 lumens output. Low luminance item thanks to recessed lens for optimal visual comfort. The 4 color temperature can be switched among 2700k, 3000k, 4000k, 6000k by the slide switch on the front of downlight. With the thermal conductive plastics heat sink, it has an impressive lifetime of 50,000 hours & 5 years warranty. Insulation coverable function means it doesn't need the extra accessories. The fitting is front IP65 rated since there is a rubber seal on the back of ring forms a close connection with the ceiling to prevent the water, suitable for any high moisture areas, such as kitchens and bathrooms. Twist & Lock interchangeable white, chrome, brushed chrome, and black bezels are optional.

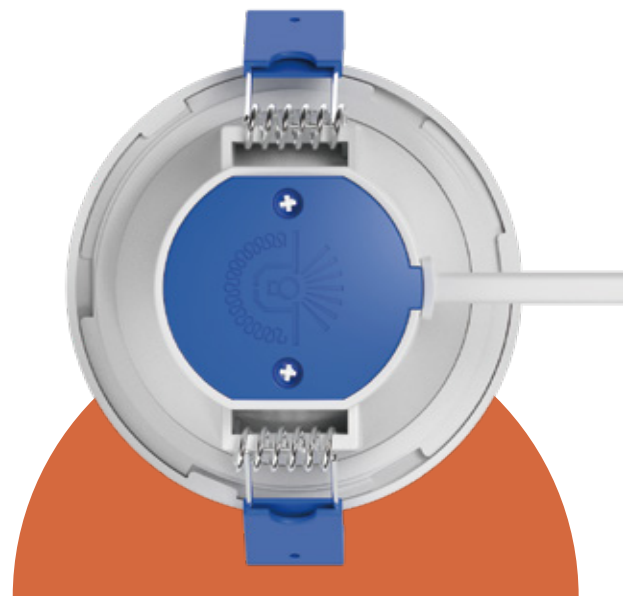
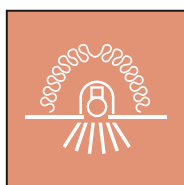
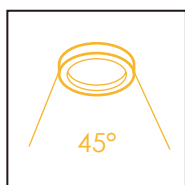
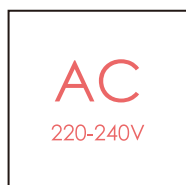
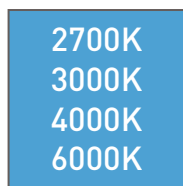
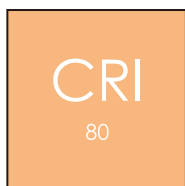

- Front CCT switchable in 2700K/3000K/4000K/6000K
- Twist & Lock interchangeable bezels options (white/black/chrome/brushed)
- Can be covered blanket & blown type insulation material IP65 front suitable in moisture areas
- Quick & easy installation thanks to the quick terminal block
- Comply with RT2012/RE2020 thermal regulations
- Long lifetime of 50,000 hours

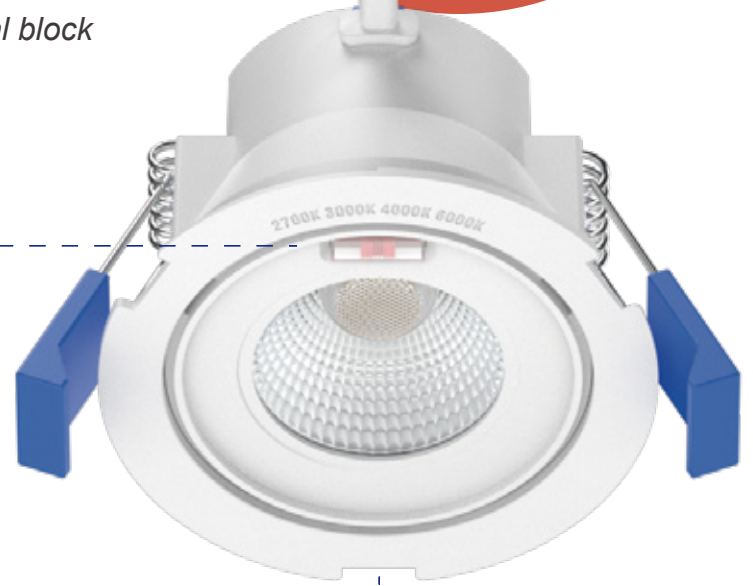
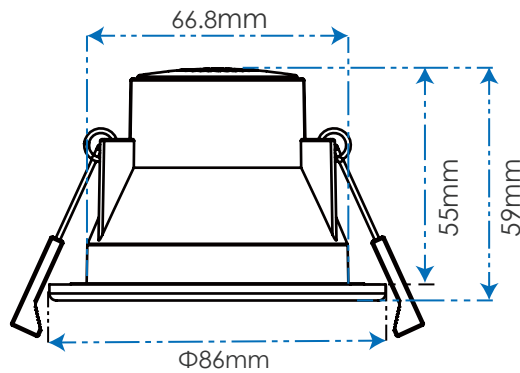

white



black



brushed



chrome

Item	Front 4CCT 6W Downlight	PF	≥0.9
Part No.	5RS209-1	IP	IP65 Front
Power	6W	Cut Out	Φ 68mm
CCT	2700K/3000K/4000K/6000K	Driver	Integrated
Lumen	510lm	Dimmable	Trailing & Leading Edge
Input	AC 220-240V~50Hz	Size	Drawing Supplied
CRI	80	LED	SMD
Beam Angle	45°	Switch Cycles	100,000
Lifespan	50,000hrs	Insulation Coverable	YES
House Material	Aluminum+Plastic	Standard	CE ROHS

**Lediant**<sup>®</sup>

Suzhou Radiant Lighting Technology Co., Ltd.

<https://www.lediant.com/>

Add: Jiatai Rd(W), Shuanglong Industrial Park, Zhangjiagang, Jiangsu, China